

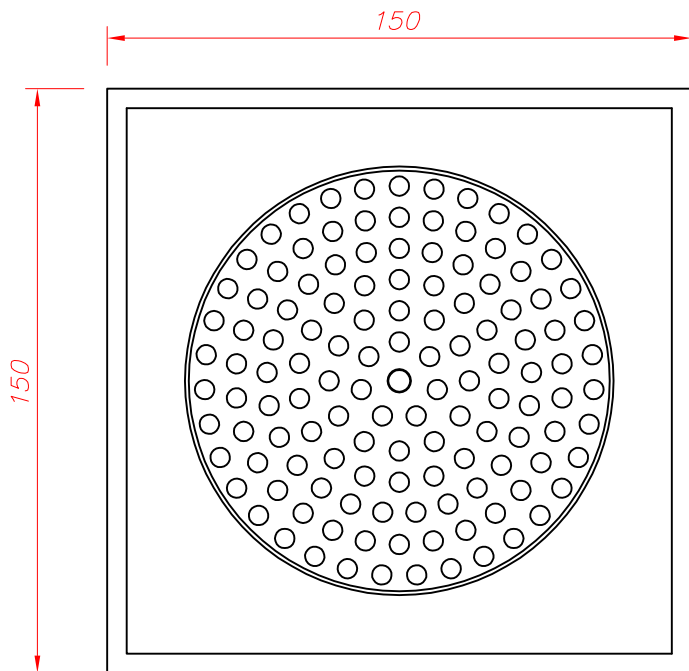

- (1) Geruchsverschluss
- (2) Schmutzfängsieb
- (3) Betonanker

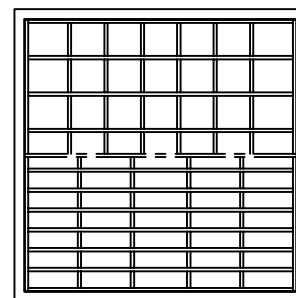

#### Abdeckungsvarianten



- Gitterrost mit Rutschhemmung  
H = 30 / 20x20 mm, L15 
- Gitterrost  
H = 30 / 30x10 mm, L15 

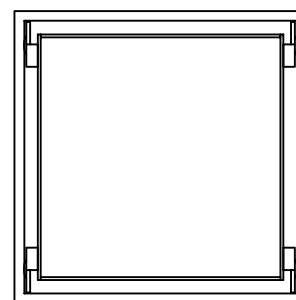

- Fliesenmulde  
H = 30 / 15 mm, K3 

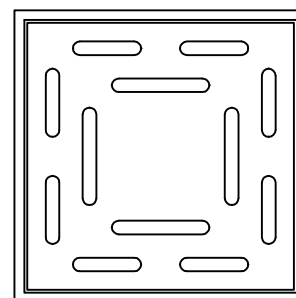

- Blechabdeckung Classic  
H = 30 / 2 mm, K3 